

PRODUCT CATALOG

Standard and Custom Products (Partial Listing)

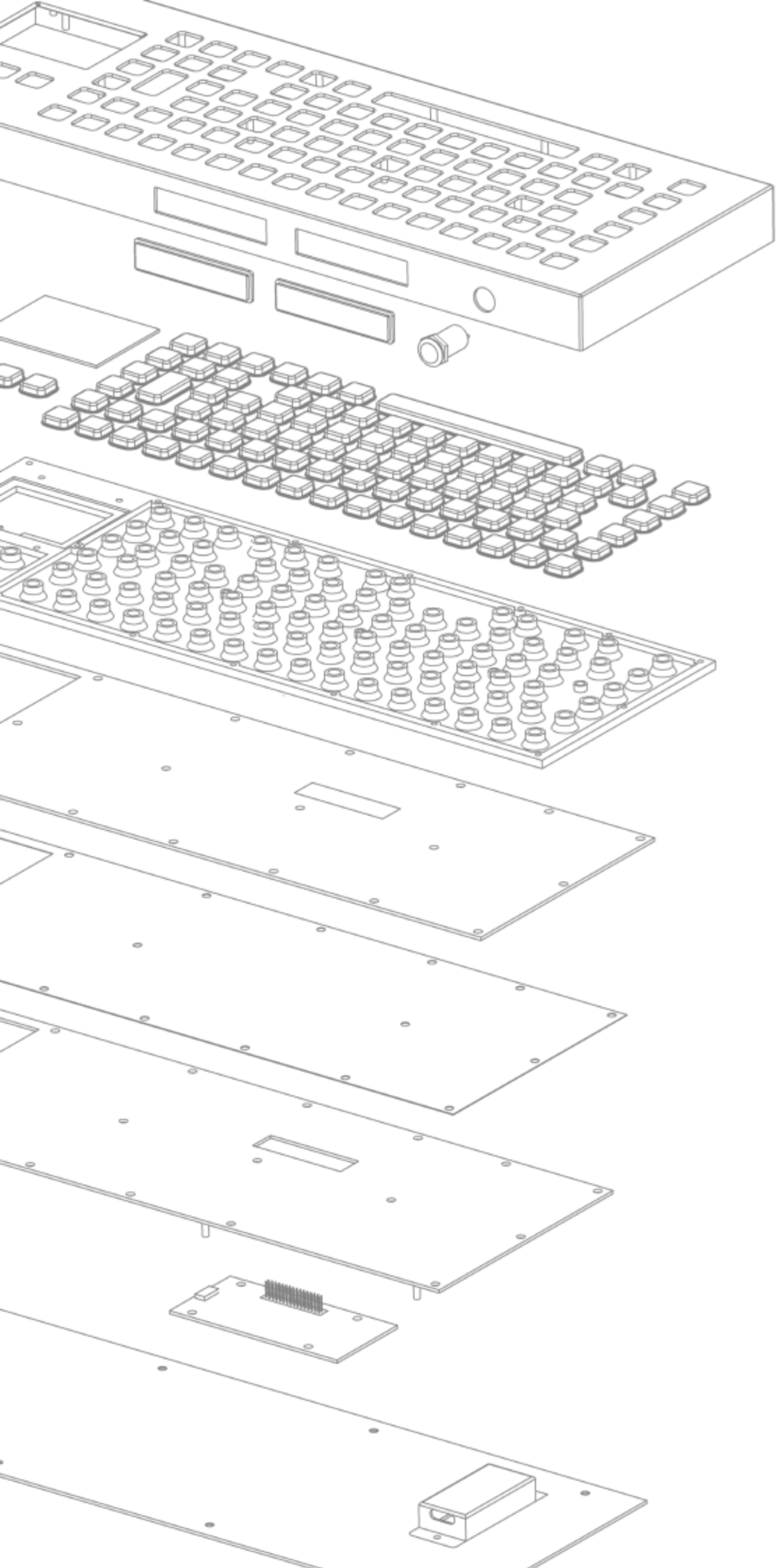



ABOUT US

DAVO

Shenzhen Davo Electronic Co., Ltd., established in 2010, is a high-tech enterprise specializing in the customization of industrial keyboards. Davo Electronic upholds the corporate values of "Customer First, People-Oriented, Keeping Promises, and Pursuing Excellence," and is committed to creating the best quality industrial keyboard brand in China. Over the years, our products have spanned over 100 industries, including coal mining, oil, chemical, medical, automation, and intelligent terminals. We have established long-term and stable partnerships with major group enterprises, research institutes, and industry partners.

Our products have passed a series of certifications, including Coal Mine Safety Certification (MA), China Compulsory Product Certification - Explosion-Proof Electrical (3C), CE, EN, RoHS, and more. The company's quality management system is certified to GB/T19001-2016/ISO9001:2015 standards.

All product development and production are independently completed by DAVO, with over 400 custom models annually in the fields of industrial keyboards and control input devices. Our products are suitable for harsh environments, including explosive, vibrating, corrosive, humid, and dusty conditions, and can withstand rigorous tests such as explosion-proof, tri-proof, electromagnetic, vibration, and other related standards.

For different customization requirements, DAVO provides standardized customization services. The extensive experience accumulated from serving clients across various industries enables Davo to quickly respond to market demands, ensure delivery timelines, and maintain product quality.

INDEX

- ① ***Stainless Steel Keyboard***
- ② ***Metal Keypad***
- ③ ***Industrial Trackball & Touchpad***
- ④ ***Rugged Keyboards and Mice (Military and Marine)***
- ⑤ ***Membrane Keyboards***
- ⑥ ***Medical Silicone Keyboards and Mice***
- ⑦ ***Glass Medical Keyboards***
- ⑧ ***Industrial Plastic Keyboard***
- ⑨ ***Customized Keyboards***

OUR CLIENTS

Why you should believe us?

Because these companies choose DAVO as a partner

SIEMENS
energy

EMERSON

posti

 **InPost**
out of the box

 **Logicbus**

TESCO



ibs
EUROPE

TCL

 **SMEC**

 **10 dream app**
Сенсорные киоски
и мониторы

JASOLAR

Schneider
Electric
 施耐德电气

 **SANY**

VLBGROUP

 **BAOSTEEL**



 **XCMG**

MarEx

Stainless Steel Keyboard

Stainless steel keyboards are engineered to meet rigorous industrial standards, utilizing robust and corrosion-resistant materials such as stainless steel, aluminum, and zinc alloy. These keyboards incorporate highly reliable industrial-grade chips and circuit designs to ensure the highest durability and performance. Designed to withstand harsh environments, they are resistant to high static, high voltage, vibration, corrosion, saline-alkali, and extreme temperatures. As a result, they maintain stable operation and have become essential tools for data input in modern industrial production.



D-8601-M(Braille)

Front Panel: 300mm×110mm
Number of keys: 65
Protection level: IP65
Interface: USB、PS2
Voltage: 5V±0.25
Temperature: -40 °C ~ 70 °C
Backlight: None



D-8601



Front Panel: 300mm×110mm
Number of keys: 65
Protection level: IP65
Interface: USB、PS2
Voltage: 5V±0.25
Temperature: -40 °C ~ 70 °C
Backlight: None

D-8656

Front Panel: 270mm×100mm
Number of keys: 65
Protection level: IP65
Interface: USB、PS2
Voltage: 5V±0.25
Temperature: -40 °C ~ 70 °C
Backlight: None



D-8675



Front Panel: 270mm×105mm
Number of keys: 67 (Plastic keys)
Protection level: IP65
Interface: USB、PS2
Voltage: 5V±0.25
Temperature: -40 °C ~ 70 °C
Backlight: Optional

D-8602



Front Panel: 392mm×110mm
Number of keys: 67
Protection level: IP65
Interface: USB、PS2
Voltage: 5V±0.25
Temperature: -40 °C ~ 70 °C
Backlight: None

D-8605



Front Panel: 478mm×135mm
Number of keys: 106
Protection level: IP65
Interface: USB、PS2
Voltage: 5V±0.25
Temperature: -40 °C ~ 70 °C
Backlight: Optional

D-8603

Front Panel: 400mm×124mm
Number of keys: 67
Protection level: IP65
Interface: USB、PS2
Voltage: 5V±0.25
Temperature: -40 °C ~ 70 °C
Backlight: None



D-8605T

Front Panel: 478mm×135mm
Number of keys: 106
Protection level: IP65
Interface: USB、PS2
Voltage: 5V±0.25
Temperature: -40 °C ~ 70 °C
Backlight: Optional



D-8606G

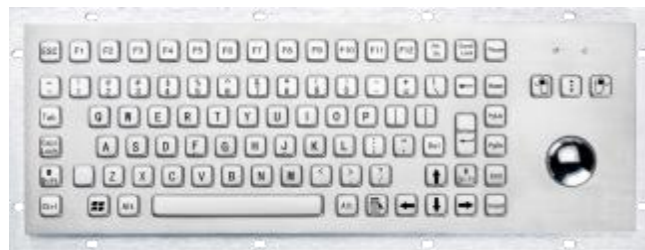

Front Panel: 392mm×135mm
Number of keys: 89
Protection level: IP65
Interface: USB、PS2
Voltage: 5V±0.25
Temperature: -40 °C ~ 70 °C
Backlight: Optional

D-8606T



Front Panel: 392mm×135mm
Number of keys: 89
Protection level: IP65
Interface: USB、PS2
Voltage: 5V±0.25
Temperature: -40 °C ~ 70 °C
Backlight: Optional

D-8605A



Front Panel: 502mm×159mm

Number of keys: 106

Protection level: IP65

Interface: USB、PS2

Voltage: 5V±0.25

Temperature: -40 °C ~ 70 °C

Backlight: Optional

D-8606G-A

Front Panel: 416mm×159mm

Number of keys: 89

Protection level: IP65

Interface: USB、PS2

Voltage: 5V±0.25

Temperature: -40 °C ~ 70 °C

Backlight: Optional



D-8606G DESK



Front Panel: 420mm×150mm x 35mm

Number of keys: 89

Protection level: IP65

Interface: USB、PS2

Voltage: 5V±0.25

Temperature: -40 °C ~ 70 °C

Backlight: Optional

D-8607



Front Panel: 392mm×110mm

Number of keys: 67

Protection level: IP65

Interface: USB、PS2

Voltage: 5V±0.25

Temperature: -40 °C ~ 70 °C

Backlight: None

D-8608

Front Panel: 400mm×124mm

Number of keys: 67

Protection level: IP65

Interface: USB、PS2

Voltage: 5V±0.25

Temperature: -40 °C ~ 70 °C

Backlight: None



D-8608DESK



Front Panel: 400mm×124mm x25mm

Number of keys: 67

Protection level: IP65

Interface: USB、PS2

Voltage: 5V±0.25

Temperature: -40 °C ~ 70 °C

Backlight: None

D-8635T



Front Panel: 329.8mm×99.8mm

Number of keys: 68

Protection level: IP65

Interface: USB、PS2

Voltage: 5V±0.25

Temperature: -40 °C ~ 70 °C

Backlight: Optional

D-8635G(Resin ball)

Front Panel: 329.8mm×99.8mm

Number of keys: 68

Protection level: IP65

Interface: USB、PS2

Voltage: 5V±0.25

Temperature: -40 °C ~ 70 °C

Backlight: Optional



D-8635T Desk



Front Panel: 348mm×118mm x 20mm

Number of keys: 68

Protection level: IP65

Interface: USB、PS2

Voltage: 5V±0.25

Temperature: -40 °C ~ 70 °C

Backlight: Optional

D-8635T Backlight



Front Panel: 329.8mm×99.8mm

Number of keys: 68

Protection level: IP65

Interface: USB、PS2

Voltage: 5V±0.25

Temperature: -40 °C ~ 70 °C

Backlight: Optional

D-8635G Backlight

Front Panel: 329.8mm×99.8mm

Number of keys: 68

Protection level: IP65

Interface: USB、PS2

Voltage: 5V±0.25

Temperature: -40 °C ~ 70 °C

Backlight: Optional



D-8635G-S(steel ball)



Front Panel: 329.8mm×99.8mm

Number of keys: 68

Protection level: IP65

Interface: USB、PS2

Voltage: 5V±0.25

Temperature: -40 °C ~ 70 °C

Backlight: Optional

D-8635G-B



Front Panel: 329.8mm×99.8mm
Number of keys: 68
Protection level: IP65
Interface: USB、PS2
Voltage: 5V±0.25
Temperature: -40 °C ~ 70 °C
Backlight: Optional

D-8630G



Front Panel: 288mm×101mm
Number of keys: 68
Protection level: IP65
Interface: USB、PS2
Voltage: 5V±0.25
Temperature: -40 °C ~ 70 °C
Backlight: Optional

D-8635G-M (Braille)

Front Panel: 329.8mm×99.8mm
Number of keys: 68
Protection level: IP65
Interface: USB、PS2
Voltage: 5V±0.25
Temperature: -40 °C ~ 70 °C
Backlight: None



D-8630T

Front Panel: 288mm×101mm
Number of keys: 68
Protection level: IP65
Interface: USB、PS2
Voltage: 5V±0.25
Temperature: -40 °C ~ 70 °C
Backlight: None



D-8625



Front Panel: 406mm×135mm
Number of keys: 103
Protection level: IP65
Interface: USB、PS2
Voltage: 5V±0.25
Temperature: -40 °C ~ 70 °C
Backlight: Optional

D-8669



Front Panel: 343mm×125mm
Number of keys: 79
Protection level: IP65
Interface: USB、PS2
Voltage: 5V±0.25
Temperature: -40 °C ~ 70 °C
Backlight: None

D-8625A



Front Panel: 430mm×159mm
Number of keys: 103
Protection level: IP65
Interface: USB、PS2
Voltage: 5V±0.25
Temperature: -40 °C ~ 70 °C
Backlight: None

D-8669A



Front Panel: 264.8mm×125mm
Number of keys: 79
Protection level: IP65
Interface: USB、PS2
Voltage: 5V±0.25
Temperature: -40 °C ~ 70 °C
Backlight: None

D-8625 DESK

Front Panel: 418mm×147mm x 25mm
Number of keys: 103
Protection level: IP65
Interface: USB、PS2
Voltage: 5V±0.25
Temperature: -40 °C ~ 70 °C
Backlight: None



D-8609-1 DESK

Front Panel: 298mm×138mm x25mm
Number of keys: 84
Protection level: IP65
Interface: USB、PS2
Voltage: 5V±0.25
Temperature: -40 °C ~ 70 °C
Backlight: None



D-8611 DESK



Front Panel: 420mm×155 x 27.5 mm
Number of keys: 89
Protection level: IP65
Interface: USB、PS2
Voltage: 5V±0.25
Temperature: -40 °C ~ 70 °C
Backlight: None

D-8641



Front Panel: 330mm×140mm
Number of keys: 65
Protection level: IP65
Interface: USB、PS2
Voltage: 5V±0.25
Temperature: -40 °C ~ 70 °C
Backlight: None

D-8670



Front Panel: 319mm×135mm

Number of keys: 86

Protection level: IP65

Interface: USB、PS2

Voltage: 5V±0.25

Temperature: -40 °C ~ 70 °C

Backlight: Optional

D-8677



Front Panel: 329.8mm×99.8mm

Number of keys: 68

Protection level: IP65

Interface: USB、PS2

Voltage: 5V±0.25

Temperature: -40 °C ~ 70 °C

Backlight: None

D-8670 DESK

Front Panel: 340mm×160mm x 25mm

Number of keys: 86

Protection level: IP65

Interface: USB、PS2

Voltage: 5V±0.25

Temperature: -40 °C ~ 70 °C

Backlight: Optional



D-8667

Front Panel: 404mm×154mm

Number of keys: 85

Protection level: IP54

Interface: USB、PS2

Voltage: 5V±0.25

Temperature: -40 °C ~ 70 °C

Backlight: None



D-8696 DESK



Front Panel: 360mm×150 x 20 mm

Number of keys: 87

Protection level: IP65

Interface: USB、PS2

Voltage: 5V±0.25

Temperature: -40 °C ~ 70 °C

Backlight: None

D-8697



Front Panel: 363mm×132mm

Number of keys: 99

Protection level: IP54

Interface: USB、PS2

Voltage: 5V±0.25

Temperature: -40 °C ~ 70 °C

Backlight: None

FHJ3W (Wireless)



Front Panel: 420mm×150mm x28mm

Number of keys: 89

Protection level: IP65

Interface: USB、PS2

Voltage: 5V±0.25

Temperature: -40 °C ~ 70 °C

Backlight: None

D-86101



Front Panel: 360mm×125mm

Number of keys: 68

Protection level: IP65

Interface: USB、PS2

Voltage: 5V±0.25

Temperature: -40 °C ~ 70 °C

Backlight: Optional

D- 8605DESK

Front Panel: 500mm×160mm x36mm

Number of keys: 106

Protection level: IP65

Interface: USB、PS2

Voltage: 5V±0.25

Temperature: -40 °C ~ 70 °C

Backlight: None



D- 8622 DESK



Front Panel: 400mm×124mm x 23.5mm

Number of keys: 73

Protection level: IP65

Interface: USB、PS2

Voltage: 5V±0.25

Temperature: -40 °C ~ 70 °C

Backlight: None

Metal Keypad

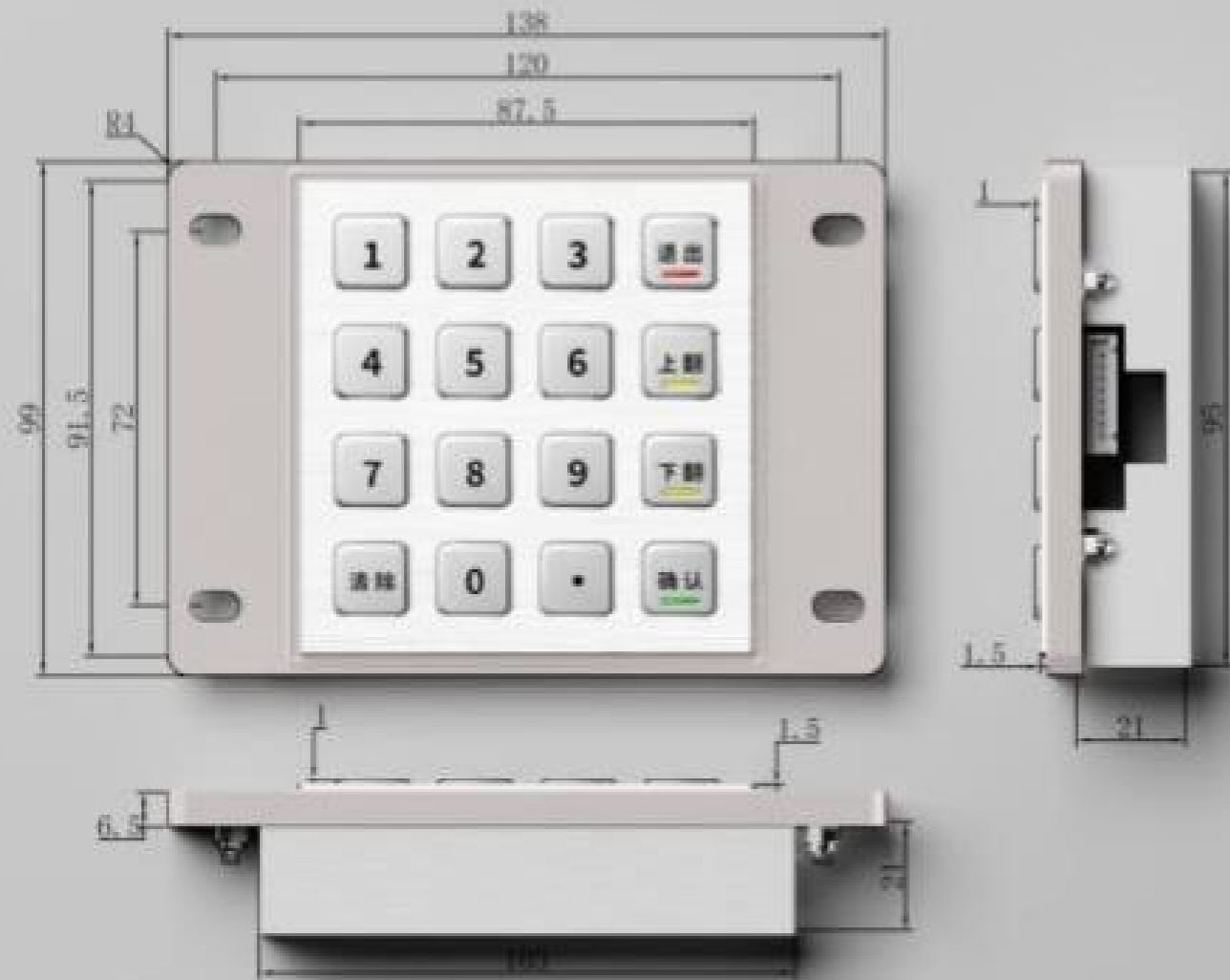

DAVO offers a range of small keypads in various sizes, interfaces, and functions to meet different operational and functional needs.

Additionally, we provide options for backlighting and Braille configurations. Most products can achieve IP54 and IP65 protection levels when properly installed, with some products reaching up to IP68 protection.

D-8201F

Front Panel: 100mm×100mm

Number of keys: 16

Protection level: IP65

Interface: USB、PS2、RS232、Marix

Voltage: 5V±0.25

Temperature: -40 °C ~ 70 °C

Backlight: None



D-8203

Front Panel: 87.5mm×91.5mm

Number of keys: 16

Protection level: IP54

Interface: USB、PS2、RS232、Marix

Voltage: 5V±0.25

Temperature: -40 °C ~ 70 °C

Backlight: None



D-8203K

Front Panel: 87.5mm×91.5mm

Number of keys: 16

Protection level: IP54

Interface: USB、PS2、RS232、Marix

Voltage: 5V±0.25

Temperature: -40 °C ~ 70 °C

Backlight: Optional



D-8203B

Front Panel: 87.5mm×91.5mm

Number of keys: 16

Protection level: IP65

Interface: USB、PS2、RS232、Marix

Voltage: 5V±0.25

Temperature: -40 °C ~ 70 °C

Backlight: None



D-8204E

Front Panel: 100mm×91.5mm
Number of keys: 16
Protection level: IP54
Interface: USB、PS2、RS232、Matrix
Voltage: 5V±0.25
Temperature: -40 °C ~ 70 °C
Backlight: None



D-8204B

Front Panel: 100mm×91.5mm
Number of keys: 16
Protection level: IP65
Interface: USB、PS2、RS232、Matrix
Voltage: 5V±0.25
Temperature: -40 °C ~ 70 °C
Backlight: Optional



D-8281C

Front Panel: 116mm×95mm
Number of keys: 16
Protection level: IP65
Interface: USB、PS2、RS232、Matrix
Voltage: 5V±0.25
Temperature: -40 °C ~ 70 °C
Backlight: Optional

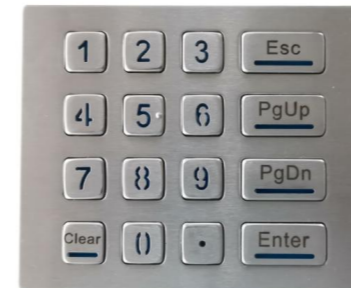

D-8988

Front Panel: 100mm×91.5mm
Number of keys: 16
Protection level: IP68
Interface: USB、
Voltage: 5V±0.25
Temperature: -40 °C ~ 70 °C
Backlight: Optional



D-8291

Front Panel: 54mm×54mm
Number of keys: 16
Protection level: IP54
Interface: USB、PS2、RS232、Matrix
Voltage: 5V±0.25
Temperature: -40 °C ~ 70 °C
Backlight: None



D-87158

Front Panel: 60mm×57mm
Number of keys: 16
Protection level: IP65
Interface: USB、PS2、RS232、Matrix
Voltage: 5V±0.25
Temperature: -40 °C ~ 70 °C
Backlight: Optional



D-2201 (Touch Keypad)

Front Panel: 87.5mm×91.5mm
Number of keys: 16
Protection level: IP65
Interface: USB、
Voltage: 5V±0.25
Temperature: -40 °C ~ 70 °C
Backlight: None



D-8216

Front Panel: 160mm x102.4mm
Number of keys: 16
Protection level: IP65
Interface: USB、PS2、RS232、Matrix
Voltage: 5V±0.25
Temperature: -40 °C ~ 70 °C
Backlight: None

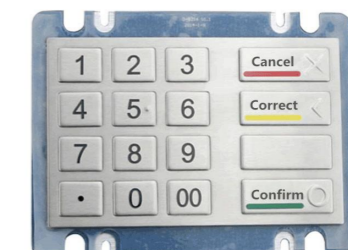

D-8208J

Front Panel: 88mm×102mm
Number of keys: 12
Protection level: IP65
Interface: USB、PS2、RS232、Matrix
Voltage: 5V±0.25
Temperature: -40 °C ~ 70 °C
Backlight: Optional



D-8208J-1

Front Panel: 68mm×90mm
Number of keys: 12
Protection level: IP65
Interface: USB、PS2、RS232、Matrix
Voltage: 5V±0.25
Temperature: -40 °C ~ 70 °C
Backlight: Optional



D-8208

Front Panel: 76.5mm x 92mm
Number of keys: 12
Protection level: IP54
Interface: USB、PS2、RS232、Matrix
Voltage: 5V±0.25
Temperature: -40 °C ~ 70 °C
Backlight: None



D-8208A

Front Panel: 76.5mm x 92mm
Number of keys: 12
Protection level: IP65
Interface: USB、PS2、RS232、Matrix
Voltage: 5V±0.25
Temperature: -40 °C ~ 70 °C
Backlight: Optional



D-8208H

Front Panel: 100mm×95mm
Number of keys: 12
Protection level: IP54
Interface: USB、PS2、RS232、Matrix
Voltage: 5V±0.25
Temperature: -40 °C ~ 70 °C
Backlight: Optional



D-8208J-2 (Braille)

Front Panel: 68mm×90mm
Number of Keys: 12
Protection level: IP66
Interface: USB、PS2、RS232、Matrix
Voltage: 5V±0.25
Temperature: -40 °C ~ 70 °C
Backlight: None



D-8935

Front Panel: 114mm×66mm
Number of keys: 12
Protection level: IP54
Interface: Matrix
Voltage: 5V±0.25
Temperature: -40 °C ~ 70 °C
Backlight: None



D-8832

Front Panel: 55 mm x55mm
Number of keys: 12
Protection level: IP54
Interface: Matrix
Voltage: 5V±0.25
Temperature: -40 °C ~ 70 °C
Backlight: None



D-87150

Front Panel: 90mm×120 x 25mm
Number of keys: 12
Protection level: IP65
Interface: USB、PS2、RS232、Matrix
Voltage: 5V±0.25
Temperature: -40 °C ~ 70 °C
Backlight: Optional



D-89145 V2.0

Front Panel: 120mm×180mm
Number of keys: 12
Protection level: IP65
Interface: USB、PS2、RS232、Matrix
Voltage: 5V±0.25
Temperature: -40 °C ~ 70 °C
Backlight: Optional



D-89141

Front Panel: 105.5mm x 211mm
Number of keys: 12
Protection level: IP54
Interface: USB、PS2、RS232、Matrix
Voltage: 5V±0.25
Temperature: -40 °C ~ 70 °C
Backlight: None



D-8215

Front Panel: 150mm x 74mm
Number of keys: 15
Protection level: IP54
Interface: USB、PS2、RS232、Matrix
Voltage: 5V±0.25
Temperature: -40 °C ~ 70 °C
Backlight: None



D-8225A

Front Panel: 83.8mm×114mm
Number of keys: 15
Protection level: IP54
Interface: USB、PS2、RS232、Matrix
Voltage: 5V±0.25
Temperature: -40 °C ~ 70 °C
Backlight: None



D-8218B

Front Panel: 90mm×60mm
Number of Keys: 15
Protection level: IP65
Interface: USB、PS2、RS232、Matrix
Voltage: 5V±0.25
Temperature: -40 °C ~ 70 °C
Backlight: None



D-8206

Front Panel: 150mm×74mm
Number of keys: 18
Protection level: IP54
Interface: USB、PS2、RS232、Matrix
Voltage: 5V±0.25
Temperature: -40 °C ~ 70 °C
Backlight: None



D-8212

Front Panel: 90mm x110mm
Number of keys: 18
Protection level: IP65
Interface: USB
Voltage: 5V±0.25
Temperature: -40 °C ~ 70 °C
Backlight: None



D-8909

Front Panel: 77.8mm×162.8mm
Number of keys: 18
Protection level: IP54
Interface: USB、PS2、RS232、Matrix
Voltage: 5V±0.25
Temperature: -40 °C ~ 70 °C
Backlight: None



D-8292

Front Panel: 60mm×92.2mm
Number of keys: 18
Protection level: IP65
Interface: USB、PS2、RS232、Matrix
Voltage: 5V±0.25
Temperature: -40 °C ~ 70 °C
Backlight: Optional



D-8206 BG

Front Panel: 150mm x 74mm
Number of keys: 18
Protection level: IP54
Interface: USB、PS2、RS232、Matrix
Voltage: 5V±0.25
Temperature: -40 °C ~ 70 °C
Backlight: Optional



D-8239

Front Panel: 112mm x 59mm
Number of keys: 15
Protection level: IP54
Interface: USB、PS2、RS232、Matrix
Voltage: 5V±0.25
Temperature: -40 °C ~ 70 °C
Backlight: None



D-8206 DESK

Front Panel: 205mm×100mm x 30mm
Number of keys: 18
Protection level: IP54
Interface: USB、PS2、RS232
Voltage: 5V±0.25
Temperature: -40 °C ~ 70 °C
Backlight: None



D-8210

Front Panel: 120mm×90mm
Number of Keys: 20
Protection level: IP54
Interface: USB、PS2、RS232、Matrix
Voltage: 5V±0.25
Temperature: -40 °C ~ 70 °C
Backlight: None



D-82105

Front Panel: 120mm×146mm
Number of keys: 20
Protection level: IP54
Interface: Matrix
Voltage: 5V±0.25
Temperature: -40 °C ~ 70 °C
Backlight: None



D-87130

Front Panel: 130mm x 110mm
Number of keys: 20
Protection level: IP54
Interface: USB、PS2、RS232、Matrix
Voltage: 5V±0.25
Temperature: -40 °C ~ 70 °C
Backlight: None



D-8246

Front Panel: 90mm×110mm
Number of keys: 20
Protection level: IP54
Interface: USB、PS2、RS232、Matrix
Voltage: 5V±0.25
Temperature: -40 °C ~ 70 °C
Backlight: None



D-82118

Front Panel: 66mm×81mm
Number of keys: 20
Protection level: IP66
Interface: Matrix
Voltage: 5V±0.25
Temperature: -40 °C ~ 70 °C
Backlight: None



D-8247

Front Panel: 64mm x 85mm
Number of keys: 11
Protection level: IP54
Interface: USB、PS2、RS232、Matrix
Voltage: 5V±0.25
Temperature: -40 °C ~ 70 °C
Backlight: None



D-8226

Front Panel: 104mm x 46mm
Number of keys: 8
Protection level: IP54
Interface: USB、PS2、RS232、Matrix
Voltage: 5V±0.25
Temperature: -40 °C ~ 70 °C
Backlight: None



D-8208-7

Front Panel: 76.5mm×92mm
Number of keys: 7
Protection level: IP54
Interface: USB、PS2、RS232
Voltage: 5V±0.25
Temperature: -40 °C ~ 70 °C
Backlight: None



D-8296

Front Panel: 64mm×64mm
Number of Keys: 5
Protection level: IP54
Interface: Matrix
Voltage: 5V±0.25
Temperature: -40 °C ~ 70 °C
Backlight: None



D-8943

Front Panel: 90mm×80mm
Number of keys: 4
Protection level: IP54
Interface: USB、PS2、RS232、Matrix
Voltage: 5V±0.25
Temperature: -40 °C ~ 70 °C
Backlight: None



D-8539

Front Panel: 97mm x36mm
Number of keys: 10
Protection level: IP54
Interface: USB、PS2、RS232、Matrix
Voltage: 5V±0.25
Temperature: -40 °C ~ 70 °C
Backlight: None



D-8238

Front Panel: 45mm×50 mm
Number of keys: 4
Protection level: IP54
Interface: Matrix
Voltage: 5V±0.25
Temperature: -40 °C ~ 70 °C
Backlight: None



D-89118

Front Panel: 73.5mm×51.5mm
Number of keys: 6
Protection level: IP65
Interface: USB、PS2、RS232、Matrix
Voltage: 5V±0.25
Temperature: -40 °C ~ 70 °C
Backlight: None



D-8932

Front Panel: 174mm x 106mm
Number of keys: 22
Protection level: IP65
Interface: USB、PS2、RS232、Matrix
Voltage: 5V±0.25
Temperature: -40 °C ~ 70 °C
Backlight: Optional



D-8223-1

Front Panel: 108mm x 127mm
Number of keys: 26
Protection level: IP65
Interface: USB、PS2、RS232、Matrix
Voltage: 5V±0.25
Temperature: -40 °C ~ 70 °C
Backlight: Optional



D-8235

Front Panel: 150mm×65mm
Number of keys: 23
Protection level: IP54
Interface: USB、PS2、RS232、Matrix
Voltage: 5V±0.25
Temperature: -40 °C ~ 70 °C
Backlight: None



D-8933

Front Panel: 199mm×89mm
Number of Keys: 40
Protection level: IP65
Interface: USB、PS2、RS232、Matrix
Voltage: 5V±0.25
Temperature: -40 °C ~ 70 °C
Backlight: Optional



D-8289

Front Panel: 80mm×118mm
Number of keys: 24
Protection level: IP65
Interface: USB、PS2、RS232、Matrix
Voltage: 5V±0.25
Temperature: -40 °C ~ 70 °C
Backlight: Optional



D-8268A

Front Panel: 118mm x 118mm
Number of keys: 25
Protection level: IP54
Interface: USB、PS2、RS232、Matrix
Voltage: 5V±0.25
Temperature: -40 °C ~ 70 °C
Backlight: None



D-8954

Front Panel: 72mm×265 mm
Number of keys: 30
Protection level: IP65
Interface: USB、PS2、RS232、Matrix
Voltage: 5V±0.25
Temperature: -40 °C ~ 70 °C
Backlight: Optional



D-89109

Front Panel: 100mm×120mm
Number of keys: 22
Protection level: IP54
Interface: USB、PS2、RS232、Matrix
Voltage: 5V±0.25
Temperature: -40 °C ~ 70 °C
Backlight: None



D-89170

Front Panel: 240mm x 130mm
Number of keys: 24
Protection level: IP54
Interface: USB、PS2、RS232、Matrix
Voltage: 5V±0.25
Temperature: -40 °C ~ 70 °C
Backlight: None

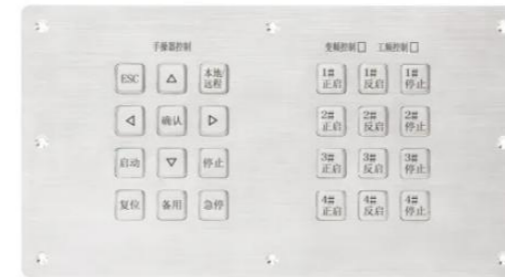

D-89138

Front Panel: 124mm x 88mm
Number of keys: 24
Protection level: IP65
Interface: USB、PS2、RS232、Matrix
Voltage: 5V±0.25
Temperature: -40 °C ~ 70 °C
Backlight: Optional



D-87135

Front Panel: 248mm×77mm
Number of keys: 24
Protection level: IP54
Interface: USB、PS2、RS232、Matrix
Voltage: 5V±0.25
Temperature: -40 °C ~ 70 °C
Backlight: None



D-8236

Front Panel: 129mm×172mm
Number of Keys: 24
Protection level: IP65
Interface: USB、PS2、RS232、Matrix
Voltage: 5V±0.25
Temperature: -40 °C ~ 70 °C
Backlight: None



D-8918

Front Panel: 254mm×130mm
Number of keys: 53
Protection level: IP54
Interface: USB、PS2、RS232、Matrix
Voltage: 5V±0.25
Temperature: -40 °C ~ 70 °C
Backlight: None



D-8845

Front Panel: 138mm x83mm
Number of keys: 28
Protection level: IP65
Interface: USB、PS2、RS232、Matrix
Voltage: 5V±0.25
Temperature: -40 °C ~ 70 °C
Backlight: None



D-8807

Front Panel: 79.4mm×155.4mm
Number of keys: 15
Protection level: IP54
Interface: USB、PS2、RS232、Matrix
Voltage: 5V±0.25
Temperature: -40 °C ~ 70 °C
Backlight: Optional



D-8958-2

Front Panel: 71.6mm×66mm
Number of keys: 22
Protection level: IP54
Interface: USB、PS2、RS232、Matrix
Voltage: 5V±0.25
Temperature: -40 °C ~ 70 °C
Backlight: None



D-8501

Front Panel: 110mm x 24mm
Number of keys: 4
Protection level: IP54
Interface: USB、PS2、RS232、Matrix
Voltage: 5V±0.25
Temperature: -40 °C ~ 70 °C
Backlight: None



D-8518

Front Panel: 110mm x 22mm
Number of keys: 5
Protection level: IP54
Interface: USB、PS2、RS232、Matrix
Voltage: 5V±0.25
Temperature: -40 °C ~ 70 °C
Backlight: None



D-8503

Front Panel: 150mm×26mm
Number of keys: 6
Protection level: IP54
Interface: USB、PS2、RS232、Matrix
Voltage: 5V±0.25
Temperature: -40 °C ~ 70 °C
Backlight: None



D-8513

Front Panel: 145mm×20mm
Number of Keys: 7
Protection level: IP54
Interface: USB、PS2、RS232、Matrix
Voltage: 5V±0.25
Temperature: -40 °C ~ 70 °C
Backlight: None



D-8517

Front Panel: 480mm×24mm
Number of keys: 10
Protection level: IP54
Interface: USB、PS2、RS232、Matrix
Voltage: 5V±0.25
Temperature: -40 °C ~ 70 °C
Backlight: None



D-8529

Front Panel: 42mm x18mm
Number of keys: 2
Protection level: IP65
Interface: USB、PS2、RS232、Matrix
Voltage: 5V±0.25
Temperature: -40 °C ~ 70 °C
Backlight: None



D-87110

Front Panel: 165mm×150mm

Number of keys: 16

Protection level: IP65

Interface: RS232、Matrix

Voltage: 5V±0.25

Temperature: -40 °C ~ 70 °C

Backlight: None



D-8509

Front Panel: 150mm x 35mm

Number of keys: 4

Protection level: IP54

Interface: USB、PS2、RS232、Matrix

Voltage: 5V±0.25

Temperature: -40 °C ~ 70 °C

Backlight: None



D-89201

Front Panel: 118*122*22mm

Number of keys: 18

Protection level: IP65

Interface: USB、

Voltage: 5V±0.25

Temperature: -40 °C ~ 70 °C

Backlight: None



D-89202

Front Panel: 118*122mm

Number of keys: 18

Protection level: IP65

Interface: USB

Voltage: 5V±0.25

Temperature: -40 °C ~ 70 °C

Backlight: None



D-89218

Front Panel: 101.5mm×119.5mm

Number of keys: 28

Protection level: IP54

Interface: Matrix

Voltage: 5V±0.25

Temperature: -40 °C ~ 70 °C

Backlight: None



Industrial Trackball & Touchpad

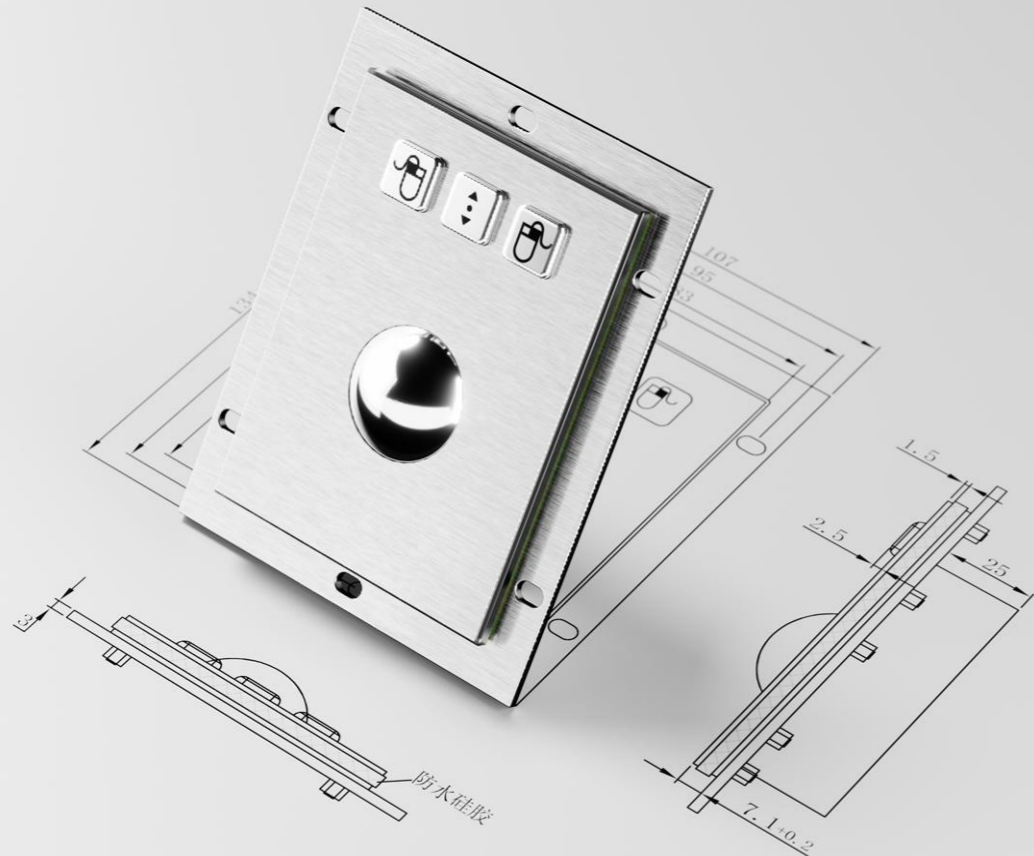

Our industrial trackballs and touchpads are designed for high-performance and reliability in demanding environments.

Featuring precise and responsive control, they are ideal for use in applications where traditional mice or keyboards may fail, including industrial automation, military operations, medical equipment, and marine navigation.

Available in various sizes and configurations, our trackballs and touchpads can be customized to meet specific requirements, ensuring seamless integration and optimal performance in any industrial setting.

D-8302

Front Panel: 83 mm×110mm

Number of keys: 3

Protection level: IP54

Interface: USB、PS2

Voltage: 5V±0.25

Temperature: -40 °C ~ 70 °C

Backlight: None



D-8302-36A

Front Panel: 83 mm×110mm

Number of keys: 3

Protection level: IP54

Interface: USB、PS2

Voltage: 5V±0.25

Temperature: -40 °C ~ 70 °C

Backlight: None



D-8338

Front Panel: 66 mm×66mm

Number of keys: 2

Protection level: IP54

Interface: USB、PS2

Voltage: 5V±0.25

Temperature: -40 °C ~ 70 °C

Backlight: None



DS36B

Front Panel: 77.8 mm×99.8mm

Number of keys: 3

Protection level: IP54

Interface: USB、PS2

Voltage: 5V±0.25

Temperature: -40 °C ~ 70 °C

Backlight: None



D-8326

Front Panel: 88mm×100mm

Ball diameter: 36mm

Protection level: IP54

Interface: USB、PS2

Voltage: 5V±0.25

Temperature: -40 °C ~ 70 °C

Backlight: Optional



D-8302 DESK

Front Panel: 90mm×120mm x 35mm

Ball diameter: 38mm

Protection level: IP54

Interface: USB、PS2

Voltage: 5V±0.25

Temperature: -40 °C ~ 70 °C

Backlight: None



DS36A

Front Panel: 58.7mm×58.7mm

Ball diameter: 36mm

Protection level: IP54

Interface: USB、PS2

Voltage: 5V±0.25

Temperature: -40 °C ~ 70 °C

Backlight: Optional



DS36R

Front Panel: 58.6mm×58.6mm

Ball diameters: 36mm

Protection level: IP54

Interface: USB、PS2

Voltage: 5V±0.25

Temperature: -40 °C ~ 70 °C

Backlight: None



D-8328

Front Panel: 65mm×74mm

Number of keys: 3

Protection level: IP54

Interface: USB、PS2

Voltage: 5V±0.25

Temperature: -40 °C ~ 70 °C

Backlight: None



D-XH-C38 (optical)

Front Panel: 58.0×58.0×37.5

Ball diameter: 36mm

Protection level: IP68

Interface: USB、PS2

Voltage: 5V±0.25

Temperature: -40 °C ~ 70 °C

Backlight: None



DS38S

Front Panel: 74mm×57mm

Ball diameter: 38mm

Protection level: IP54

Interface: USB、PS2

Voltage: 5V±0.25

Temperature: -40 °C ~ 70 °C

Backlight: None



D-25TB-J

Front Panel: 40mm×40mm

Ball diameter: 25mm

Protection level: IP54

Interface: USB、PS2

Voltage: 5V±0.25

Temperature: -40 °C ~ 70 °C

Backlight: None



D-JS50A

Front Panel: 73mm×73mm
Ball diameter: 50mm
Protection level: IP54
Interface: USB、PS2
Voltage: 5V±0.25
Temperature: -40 °C ~ 70 °C
Backlight: None



D-JS50B

Front Panel: 73mm×73mm
Ball diameter: 50mm
Protection level: IP54
Interface: USB、PS2
Voltage: 5V±0.25
Temperature: -40 °C ~ 70 °C
Backlight: None



D-BS50

Front Panel: 77.7mm×77.7mm
Ball diameter: 50mm
Protection level: IP54
Interface: USB、PS2
Voltage: 5V±0.25
Temperature: -40 °C ~ 70 °C
Backlight: None



D-JS50E

Front Panel: 70.6mm×70.6mm
Ball diameter: 50mm
Protection level: IP54
Interface: USB、PS2
Voltage: 5V±0.25
Temperature: -40 °C ~ 70 °C
Backlight: None



DS60

Front Panel:
Ball diameter: 60mm
Protection level: IP54
Interface: USB、PS2
Voltage: 5V±0.25
Temperature: -40 °C ~ 70 °C
Backlight: None



D-34TB

Front Panel:
Ball diameter: 34mm
Protection level: IP54
Interface: USB、PS2
Voltage: 5V±0.25
Temperature: -40 °C ~ 70 °C
Backlight: None



D-XH50

Front Panel: 62.5×62.5×61.5mm
Ball diameter: 50mm
Protection level: IP65
Interface: USB
Voltage: 5V±0.25
Temperature: -40 °C ~ 70 °C
Backlight: None



D-XH-C50

Front Panel: 70.0×70.0×52.4mm
Ball diameter: 50mm
Protection level: IP68
Interface: USB
Voltage: 5V±0.25
Temperature: -40 °C ~ 70 °C
Backlight: None



C50

D-8458

Front Panel: 83mm×110mm

Number of keys: 3

Protection level: IP65

Interface: USB、PS2

Voltage: 5V±0.25

Temperature: -40 °C ~ 70 °C

Backlight: None



D-8402

Front Panel: 80mm×80mm

Number of keys: 2

Protection level: IP65

Interface: USB、PS2

Voltage: 5V±0.25

Temperature: -40 °C ~ 70 °C

Backlight: None



D-8410

Front Panel: 100mm×91.5mm

Number of keys: 12

Protection level: IP65

Interface: USB、PS2

Voltage: 5V±0.25

Temperature: -40 °C ~ 70 °C

Backlight: None



D-8405T

Front Panel: 176mm×110mm

Number of keys: 21

Protection level: IP65

Interface: USB、PS2

Voltage: 5V±0.25

Temperature: -40 °C ~ 70 °C

Backlight: None



D-8405A

Front Panel: 127mm×94mm

Number of keys: 17

Protection level: IP65

Interface: USB、PS2

Voltage: 5V±0.25

Temperature: -40 °C ~ 70 °C

Backlight: None



D-8433

Front Panel: 145mm×180mm

Number of keys: 20

Protection level: IP54

Interface: USB、PS2

Voltage: 5V±0.25

Temperature: -40 °C ~ 70 °C

Backlight: None



Rugged Keyboards and Mice



Our rugged keyboards and mice are engineered to meet the rigorous demands of military applications.

Available in various configurations and customizable to specific operational requirements, our military keyboards and mice ensure seamless integration and superior performance in the most demanding military settings.

D-6205



Front Panel: 276mm×118.8mm

Number of keys: 81

Protection level: IP66

Interface: USB、PS2

Voltage: 5V±0.25

Temperature: -40 °C ~ 70 °C

Backlight: None

D-6207

Front Panel: 283mm×153.6mm

Number of keys: 88

Protection level: IP66

Interface: USB、PS2

Voltage: 5V±0.25

Temperature: -40 °C ~ 70 °C

Backlight: None



D-6210



Front Panel: 368mm×148mm

Number of keys: 124

Protection level: IP66

Interface: USB、PS2

Voltage: 5V±0.25

Temperature: -40 °C ~ 70 °C

Backlight: None

D-6209



Front Panel: 280.55x177.43mm
Number of keys: 89
Protection level: IP66
Interface: USB、PS2
Voltage: 5V±0.25
Temperature: -40 °C ~ 70 °C
Backlight: Blue backlight

D- 8679



Front Panel: 320x160mm
Number of keys: 49
Protection level: IP66
Interface: USB、PS2
Voltage: 5V±0.25
Temperature: -40 °C ~ 70 °C
Backlight: None

D-8633 DESK



Front Panel: 412.75x200.13mmx45.71mm
Number of keys: 124
Protection level: IP66
Interface: USB、PS2
Voltage: 5V±0.25
Temperature: -40 °C ~ 70 °C
Backlight: None

D- 87115

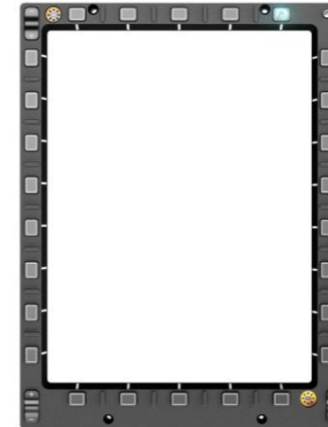

Front Panel: 192x252mm
Number of keys: 26
Protection level: IP54
Interface: USB
Voltage: 5V±0.25
Temperature: -40 °C ~ 70 °C
Backlight: None

D-8339



Front Panel: 129x172mm
Number of keys: 3
Protection level: IPX6
Interface: USB
Voltage: 5V±0.25
Temperature: -40 °C ~ 70 °C
Backlight: None

D-8310

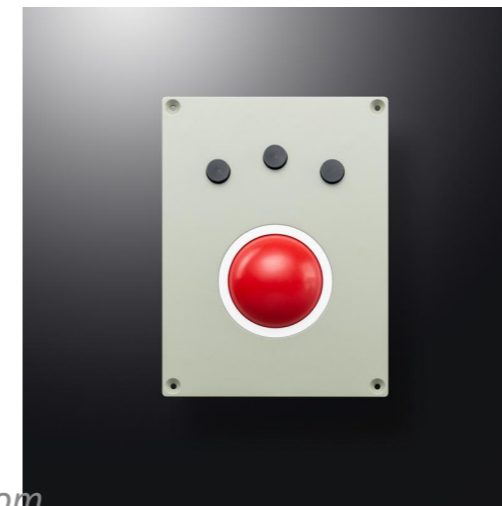

Front Panel: 127x169.5mm
Ball diameter: 60mm
Protection level: IP54
Interface: USB
Voltage: 5V±0.25
Temperature: -40 °C ~ 70 °C
Backlight: None

D-8330



Front Panel: 129.2x172mm
Ball diameter: 60mm
Protection level: IP54
Interface: USB
Voltage: 5V±0.25
Temperature: -40 °C ~ 70 °C
Backlight: None

D- 8332

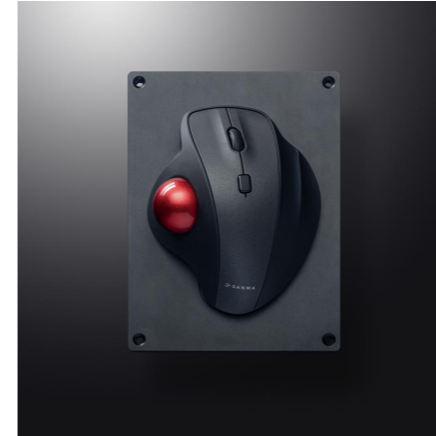

Front Panel: 129x172mm
Number of keys: 0
Protection level: IP54
Interface: USB
Voltage: 5V±0.25
Temperature: -40 °C ~ 70 °C
Backlight: None

D-5307



Front Panel: 127x 169.5mm
Ball diameter: 60mm
Protection level: IP54
Interface: USB
Voltage: 5V±0.25
Temperature: -40 °C ~ 70 °C
Backlight: None

D- 5205



Front Panel: 150x160mm
Number of keys: 0
Protection level: IP65
Interface: USB
Voltage: 5V±0.25
Temperature: -40 °C ~ 70 °C
Backlight: None

D-5303



Front Panel: 89.6x122.6mm
Ball diameter: 50mm
Protection level: IP54
Interface: USB
Voltage: 5V±0.25
Temperature: -40 °C ~ 70 °C
Backlight: None

D-5207



Front Panel: 200x175mm
Number of keys: 20
Protection level: IP65
Interface: USB
Voltage: 5V±0.25
Temperature: -40 °C ~ 70 °C
Backlight: None

D-5608



Front Panel: 440 x180 x 39mm
Number of keys: 81
Protection level: IP66
Interface: USB
Voltage: 5V±0.25
Temperature: -40 °C ~ 70 °C
Backlight: None

D-8665



Front Panel: 422mm×176mm x37.2mm
Number of keys: 107
Protection level: IP54
Interface: USB、PS2
Voltage: 5V±0.25
Temperature: -40 °C ~ 70 °C
Backlight: Optional

D-8675-5



Front Panel: 350mm×129mm
Number of keys: 67
Protection level: IP65
Interface: USB、PS2
Voltage: 5V±0.25
Temperature: -40 °C ~ 70 °C
Backlight: None

D-8666



Front Panel: 468mm×172mm x27.2mm
Number of keys: 107
Protection level: IP54
Interface: USB、PS2
Voltage: 5V±0.25
Temperature: -40 °C ~ 70 °C
Backlight: Optional

D-HY-20KEY-S2



Front Panel: 218x127mm
Number of keys: 20
Protection level: IP65
Interface: USB
Voltage: 5V±0.25
Temperature: -40 °C ~ 70 °C
Backlight: Optional

D-5616



Front Panel: 343 x159 mm
Number of keys: 86
Protection level: IP54
Interface: USB
Voltage: 5V±0.25
Temperature: -40 °C ~ 70 °C
Backlight: Optional

D-5310



Front Panel: 130 x130 mm
Ball diameter: 60mm
Protection level: IP54
Interface: USB
Voltage: 5V±0.25
Temperature: -40 °C ~ 70 °C
Backlight: None

D-6213



Front Panel: 140 x105 mm
Number of keys: 22
Protection level: IP66
Interface: USB
Voltage: 5V±0.25
Temperature: -40 °C ~ 70 °C
Backlight: None

D-8335



Front Panel: 77mm×64mm
Number of keys: 3
Protection level: IP54
Interface: USB、PS2
Voltage: 5V±0.25
Temperature: -40 °C ~ 70 °C
Backlight: None

D-6102



Front Panel: 86.8x 105.2 mm
Number of keys: 18
Protection level: IP66
Interface: USB/PS2
Voltage: 5V±0.25
Temperature: -40 °C ~ 70 °C
Backlight: None

D-5613



Front Panel: 270 x 110 mm
Number of keys: 86
Protection level: IP65
Interface: USB/PS2
Voltage: 5V±0.25
Temperature: -40 °C ~ 70 °C
Backlight: Optional

D-6218



Front Panel: 365x 135 mm
Number of keys: 96
Protection level: IP66
Interface: USB/PS2
Voltage: 5V±0.25
Temperature: -40 °C ~ 70 °C
Backlight: None

D-5609



Front Panel: 418 x192 mm
Ball diameter:
Protection level:
Interface:
Voltage:
Temperature:
Backlight: None

D-5605

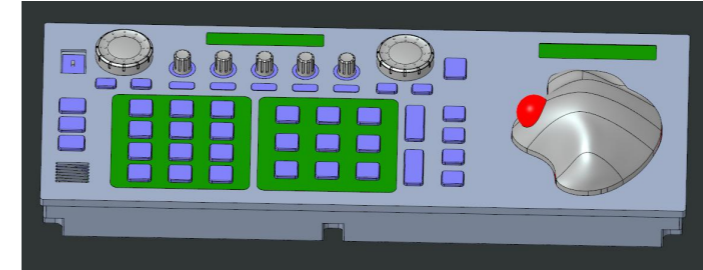

Front Panel: 440 x180 mm
Ball diameter:
Protection level:
Interface:
Voltage:
Temperature:
Backlight: None

D-8829



Front Panel: 270x130mm
Number of keys: 59
Protection level: IP65
Interface: USB
Voltage: 5V±0.25
Temperature: -40 °C ~ 70 °C
Backlight: None

D-6211



Front Panel: 281x152.5mm
Number of keys: 89
Protection level: IP66
Interface: USB
Voltage: 5V±0.25
Temperature: -40 °C ~ 70 °C
Backlight: Optional

D-6217 (with VESA mounting hole)



Front Panel: 285x185mm
Number of keys: 91
Protection level: IP68
Interface: USB
Voltage: 5V±0.25
Temperature: -40 °C ~ 70 °C
Backlight: red backlight

D-5622



Front Panel: 430x150mm
Number of keys: 82
Protection level: IP66
Interface: USB
Voltage: 5V±0.25
Temperature: -40 °C ~ 70 °C
Backlight: None

D-8688 QRS



Front Panel: 420 x 145mm
Number of keys: 70
Protection level: IP66
Interface: USB, PS2
Voltage: 5V±0.25
Temperature: -40 °C ~ 70 °C
Backlight: None

D-1603

Front Panel: 420 x 150mm
Number of keys: 94
Protection level: IP66
Interface: USB, PS2
Voltage: 5V±0.25
Temperature: -40 °C ~ 70 °C
Backlight: None



D-8765



Front Panel: 375x 157mm
Number of keys: 81
Protection level: IP66
Interface: USB, PS2
Voltage: 5V±0.25
Temperature: -40 °C ~ 70 °C
Backlight: None

Membrane Keyboards



D-8683

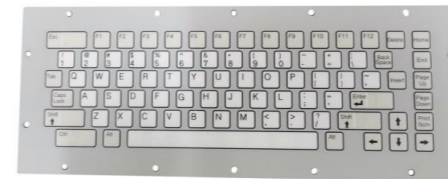

Front Panel: 263.99* 101.9mm
Number of keys: 81
Protection level: IP66
Interface: USB, PS2
Voltage: 5V±0.25
Temperature: -40 °C ~ 70 °C
Backlight: None

D-1610



Front Panel: 410 x 160 mm
Number of keys: 106
Protection level: IP66
Interface: USB
Voltage: 5V±0.25
Temperature: -20 °C ~ 65 °C
Backlight: None

D-1605C



Front Panel: 488 x 184 mm
Number of keys: 109
Protection level: IP68 Surface
Interface: USB
Voltage: 5V±0.25
Temperature: -20 °C ~ 65 °C
Backlight: None

D-1611



Front Panel: 300 x 142 mm
Number of keys: 84
Protection level: IP68 Surface
Interface: USB
Voltage: 5V±0.25
Temperature: -20 °C ~ 65 °C
Backlight: None

D-1605

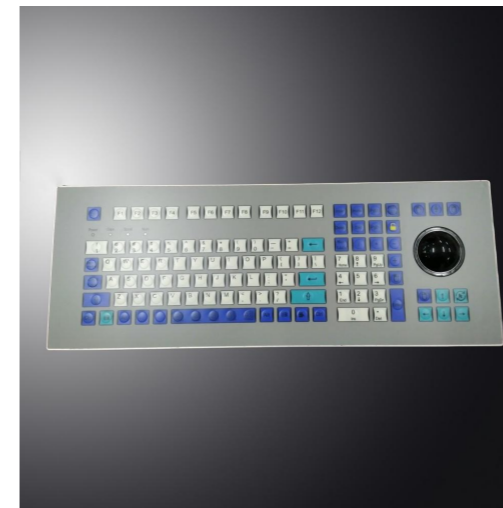

Front Panel: 488 x 184 mm
Number of keys: 109
Protection level: IP66 Surface
Interface: USB
Voltage: 5V±0.25
Temperature: -20 °C ~ 65 °C
Backlight: None

Medical Silicone Keyboards and Mice



D-87C



Front Panel: 286 x 148x 11 mm

Number of keys: 89

Protection level: IP68

Interface: USB

Voltage: 5V±0.25

Temperature: -20 °C ~ 65 °C

Backlight: Optional

D-87P

Front Panel: 346 x 136 x 12mm

Number of keys: 106

Protection level: IP68

Interface: USB

Voltage: 5V±0.25

Temperature: -20 °C ~ 65 °C

Backlight: None



D-87W



Front Panel: 380x 130x 10mm

Number of keys: 110

Protection level: IP68

Interface: USB

Voltage: 5V±0.25

Temperature: -20 °C ~ 65 °C

Backlight: Optional

D-87T



Front Panel: 365 x 136x 12 mm

Number of keys: 122

Protection level: IP68

Interface: USB

Voltage: 5V±0.25

Temperature: -20 °C ~ 65 °C

Backlight: Optional

D- 87S



Front Panel: 395 x 146 x 26 mm.

Number of keys: 106

Protection level: IP66

Interface: USB

Voltage: 5V±0.25

Temperature: -20 °C ~ 65 °C

Backlight: Optional

D-87Q



Front Panel: 409 x 139 x 11mm

Number of keys: 109

Protection level: IP68

Interface: USB

Voltage: 5V±0.25

Temperature: -20 °C ~ 65 °C

Backlight: None

D- 87R



Front Panel: 380 x 130 x 13 mm

Number of keys: 88

Protection level: IP68

Interface: USB

Voltage: 5V±0.25

Temperature: -20 °C ~ 65 °C

Backlight: Optional

D-IKB98



Front Panel: 390 x 148 x 10 mm

Number of keys: 98

Protection level: IP68

Interface: USB

Voltage: 5V±0.25

Temperature: -20 °C ~ 65 °C

Backlight: Optional

D-87Z



Front Panel: 220 x 110 x 9 mm

Number of keys: 87

Protection level: IP68

Interface: USB

Voltage: 5V±0.25

Temperature: -20 °C ~ 65 °C

Backlight: None

D-IKB310



Front Panel: 440 x 14 x 12 mm
Number of keys: 105
Protection level: IP68
Interface: USB
Voltage: 5V±0.25
Temperature: -20 °C ~ 65 °C
Backlight: Optional

D- IKB88



Front Panel: 272 x 135 x 12 mm
Number of keys: 87
Protection level: IP68
Interface: USB
Voltage: 5V±0.25
Temperature: -20 °C ~ 65°C
Backlight: None

D-IN86KB



Front Panel: 298 x 213 x 11 mm
Number of keys: 87
Protection level: IP68
Interface: USB
Voltage: 5V±0.25
Temperature: -20 °C ~ 65 °C
Backlight: None

D-IKB870



Front Panel: 343 x 228 x 13 mm
Number of keys: 91
Protection level: IP68
Interface: USB
Voltage: 5V±0.25
Temperature: -20 °C ~ 65 °C
Backlight: Optional

D-IKB85



Front Panel: 230 x 150 x 10 mm
Number of keys: 87
Protection level: IP68
Interface: USB
Voltage: 5V±0.25
Temperature: -20 °C ~ 65 °C
Backlight: None

D-IKB108



Front Panel: 445 x 180 x 20 mm
Number of keys: 104
Protection level: IP68
Interface: USB
Voltage: 5V±0.25
Temperature: -20 °C ~ 65°C
Backlight: None

D-87-W107 (Wireless)



Front Panel: 348 x 143 x 13 mm
Number of keys: 106
Protection level: IP66
Interface: 2.4 GHz
Voltage: 5V±0.25
Temperature: -20 °C ~ 65 °C
Backlight: None

D-87-W550 (Wireless)



Front Panel: 380 x 130 x 14 mm
Number of keys: 108
Protection level: IP66
Interface: 2.4 GHz
Voltage: 5V±0.25
Temperature: -20 °C ~ 65 °C
Backlight: None

D-87-W830 (Wireless)



Front Panel: 380 x 130 x 14 mm
Number of keys: 106
Protection level: IP66
Interface: 2.4 GHz
Voltage: 5V±0.25
Temperature: -20 °C ~ 65 °C
Backlight: None

D-87WT-104 (2.4G Wireless)



Front Panel: 418 x 133 x 16 mm
Number of keys: 105
Protection level: IP66
Interface: 2.4 GHz
Voltage: 5V±0.25
Temperature: -20 °C ~ 65 °C
Backlight: None

D-IBT500 (Bluetooth Wireless)



Front Panel: 418 x 133 x 16 mm
Number of keys: 105
Protection level: IP66
Interface: Bluetooth
Voltage: 5V±0.25
Temperature: -20 °C ~ 65 °C
Backlight: None

D-IKB105



Front Panel: 440 x 138 x 12 mm
Number of keys: 105
Protection level: IP68
Interface: USB
Voltage: 5V±0.25
Temperature: -20 °C ~ 65 °C
Backlight: None

D-SME10 (Optical Mouse)



Front Panel: 115 x 68 x 42 mm
Number of keys:
Protection level: IP68
interface: USB
Voltage: 5V±0.25
Temperature: -20 °C ~ 65 °C
Backlight: None

D-SME20 (Laser Mouse)



Front Panel: 115 x 68 x 42 mm
Number of keys:
Protection level: IP68
Interface: USB
Voltage: 5V±0.25
Temperature: -20 °C ~ 65 °C
Backlight: None

D-SME33 (Optical Mouse)



Front Panel: 115 x 68 x 42 mm
Number of keys:
Protection level: IP68
Interface: USB
Voltage: 5V±0.25
Temperature: -20 °C ~ 65 °C
Backlight: None

D-SME55 (Laser Mouse)



Front Panel: 115 x 68 x 42 mm
Number of keys:
Protection level: IP68
Interface: USB
Voltage: 5V±0.25
Temperature: -20 °C ~ 65°C
Backlight: None

D-87-M038 (Wireless Optical Mouse)



Front Panel: 114 x 65 x 41 mm
Number of keys
Protection level: IP65
Interface: 2.4 GHz
Voltage: 5V±0.25
Temperature: -20 °C ~ 65 °C
Backlight: None

D-87-M036 (Wireless Laser Mouse)



Front Panel: 114 x 65 x 41 mm
Number of keys
Protection level: IP65
Interface: 2.4 GHz
Voltage: 5V±0.25
Temperature: -20 °C ~ 65 °C
Backlight: None

Glass Medical Keyboards



Science Laboratory



Dentistry clinic



Beauty Salon



Pharmaceutical factory



Semiconductor factory



Operation room



Repair room



Pet hospital

D-B45-USB



Front Panel: 436 x 160x 20 mm

Number of keys: 109

Protection level: IP67

Interface: USB

Voltage: 5V±0.25

Temperature: -40 °C ~ 70 °C

Backlight: None

D-B45 (2.4G Wireless, USB, Bluetooth, 3 IN 1)

Front Panel: 436 x 160x 20 mm

Number of keys: 109

Protection level: IP67

Interface: 3 in 1

Voltage: 5V±0.25

Temperature: -40 °C ~ 70 °C

Backlight: None



D-B50



Front Panel: 436 x 160x 20 mm

Number of keys: 92

Protection level: IP67

Interface: USB

Voltage: 5V±0.25

Temperature: -40 °C ~ 70 °C

Backlight: None

Industrial Plastic Keyboard



D-87F



Front Panel: 400*135.5*13.0mm

Number of keys: 86

Protection level: IP54

Interface: USB、PS2

Voltage: 5V±0.25

Temperature: -20 °C ~ 65 °C

Backlight: None

D-87B

Front Panel: 400*135.5*13mm

Number of keys: 86

Protection level: IP54

Interface: USB、PS2

Voltage: 5V±0.25

Temperature: -20 °C ~ 65 °C

Backlight: None



D-87H



Front Panel: 315*115*2mm

Number of keys: 85

Protection level: IP54

Interface: USB

Voltage: 5V±0.25

Temperature: -20 °C ~ 65 °C

Backlight: None

D-K819



Front Panel: 260*210*14.5mm
Number of keys: 84
Protection level: IP54
Interface: USB
Voltage: 5V±0.25
Temperature: -20 °C ~ 65 °C
Backlight: None

D-87T-AZ-USB



Front Panel: 400.0 x 135.0 x 18.0mm
Number of keys: 88
Protection level: IP54
Interface: USB
Voltage: 5V±0.25
Temperature: -20 °C ~ 65 °C
Backlight: None

D-87G-USB



Front Panel: 299x154mm
Number of keys: 88
Protection level: IP54
Interface: USB
Voltage: 5V±0.25
Temperature: -20 °C ~ 65 °C
Backlight: None

D-87K-USB



Front Panel: 360 x 130 x 25mm
Number of keys: 88
Protection level: IP54
Interface: USB
Voltage: 5V±0.25
Temperature: -20 °C ~ 65 °C
Backlight: None

D-K18



Front Panel: 445*145*12mm
Number of keys: 104
Protection level: IP68
Interface: USB
Voltage: 5V±0.25
Temperature: -20 °C ~ 65 °C
Backlight: None

MKDN-19T



Front Panel: 440×355×42.5mm
Number of keys: 99
Protection level: IP54
Interface: USB
Voltage: 5V±0.25
Temperature: -20 °C ~ 60 °C
Backlight: None

Customized Keyboards



Metal Keypads Redefined

D-87140



Front Panel: 280mm×60mm

Number of keys: 45

Protection level: IP65

Interface: USB、PS2

Voltage: 5V±0.25

Temperature: -40 °C ~ 70 °C

Backlight: None

D-8321C

Front Panel: 300mm×221.5 x 55mm

Number of keys: 17

Protection level: IP54

Interface: USB、PS2

Voltage: 5V±0.25

Temperature: -40 °C ~ 70 °C

Backlight: None



D-8922



Front Panel: 359mm×165mm

Number of keys: 47

Protection level: IP65

Interface: USB、PS2

Voltage: 5V±0.25

Temperature: -40 °C ~ 70 °C

Backlight: None

D-8690



Front Panel: 418mm×154.2mm
Number of keys: 83
Protection level: IP65
Interface: USB、PS2
Voltage: 5V±0.25
Temperature: -40 °C ~ 70 °C
Backlight: None

D-8786



Front Panel: 123.6mm×93.5mm
Number of keys: 0
Protection level: IP54
Interface: USB、PS2
Voltage: 5V±0.25
Temperature: -40 °C ~ 70 °C
Backlight: None

D-5602



Front Panel: 340mm×230mm
Number of keys: 90
Protection level: IP65
Interface: USB、PS2
Voltage: 5V±0.25
Temperature: -40 °C ~ 70 °C
Backlight: None

D-8785



Front Panel: 123.6mm×93.5mm
Number of keys: 4
Protection level: IP65
Interface: USB、PS2
Voltage: 5V±0.25
Temperature: -40 °C ~ 70 °C
Backlight: None

D-8675-1



Front Panel: 482mm×200mm
Number of keys: 70
Protection level: IP65
Interface: USB、PS2
Voltage: 5V±0.25
Temperature: -40 °C ~ 70 °C
Backlight: None

D-8759

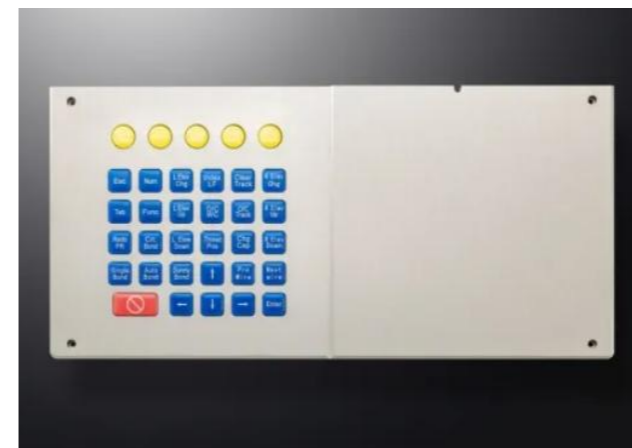

Front Panel: 384mm×185mm
Number of keys: 29
Protection level: IP65
Interface: USB、PS2
Voltage: 5V±0.25
Temperature: -40 °C ~ 70 °C
Backlight: None

D-89151



Front Panel: 416mm×130mm

Number of keys: 11

Protection level: IP54

Interface: USB、PS2

Voltage: 5V±0.25

Temperature: -40 °C ~ 70 °C

Backlight: None

D-89132

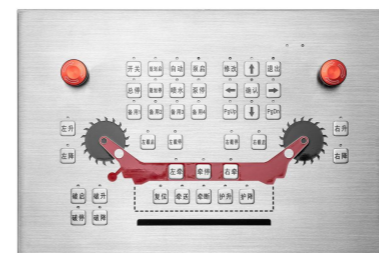

Front Panel: 450mm×300mm

Number of keys: 41

Protection level: IP54

Interface: USB、PS2

Voltage: 5V±0.25

Temperature: -40 °C ~ 70 °C

Backlight: None

D-6104



Front Panel: 197.4mm×69.4mm

Number of keys: 22

Protection level: IP65

Interface: USB、PS2

Voltage: 5V±0.25

Temperature: -40 °C ~ 70 °C

Backlight: None

D-8836



Front Panel: 300mm×170mm

Number of keys: 21

Protection level: IP54

Interface: USB、PS2

Voltage: 5V±0.25

Temperature: -40 °C ~ 70 °C

Backlight: None

D-8802

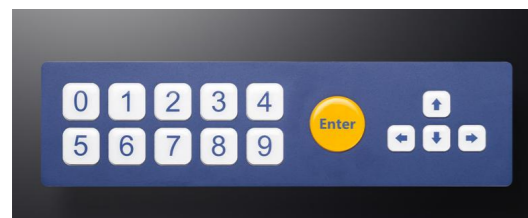

Front Panel: 360mm×95mm

Number of keys: 15

Protection level: IP65

Interface: USB、PS2

Voltage: 5V±0.25

Temperature: -40 °C ~ 70 °C

Backlight: None

D-87109



Front Panel: 132.92mm×125.92mm

Number of keys: 16

Protection level: IP66

Interface: USB、PS2

Voltage: 5V±0.25

Temperature: -40 °C ~ 70 °C

Backlight: None

D-1606 (Props)



Front Panel: 385mm×335mm

Number of keys:

Protection level: IP65

Interface:

Voltage:

Temperature:

Backlight: None

D-89169



Front Panel: 282mm×112mm

Number of keys: 20

Protection level: IP65

Interface: I2C

Voltage: 5V±0.25

Temperature: -40 °C ~ 70 °C

Backlight: Optional

D-8426 (X-ray security scanners keyboard)

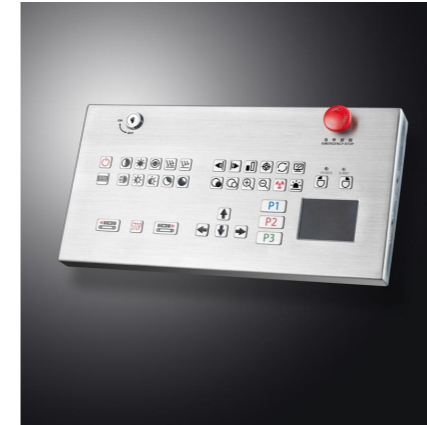

Front Panel: 370mm×190mm x 40 mm

Number of keys: 36

Protection level: IP65

Interface: USB

Voltage: 5V±0.25

Temperature: -40 °C ~ 70 °C

Backlight: None

D-8430 (X-ray security scanners keyboard)



Front Panel: 355mm×165mm x 30 mm

Number of keys: 30

Protection level: IP65

Interface: USB

Voltage: 5V±0.25

Temperature: -40 °C ~ 70 °C

Backlight: None

D-89192 (X-ray security scanners keyboard)



Front Panel: 380mm×160mm x 32mm

Number of keys: 41

Protection level: IP65

Interface: I2C

Voltage: 5V±0.25

Temperature: -40 °C ~ 70 °C

Backlight: None

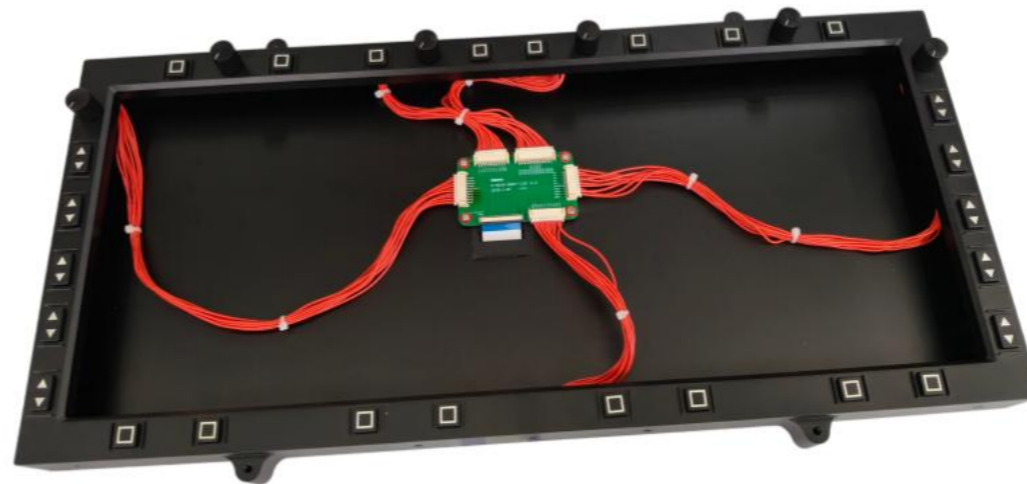
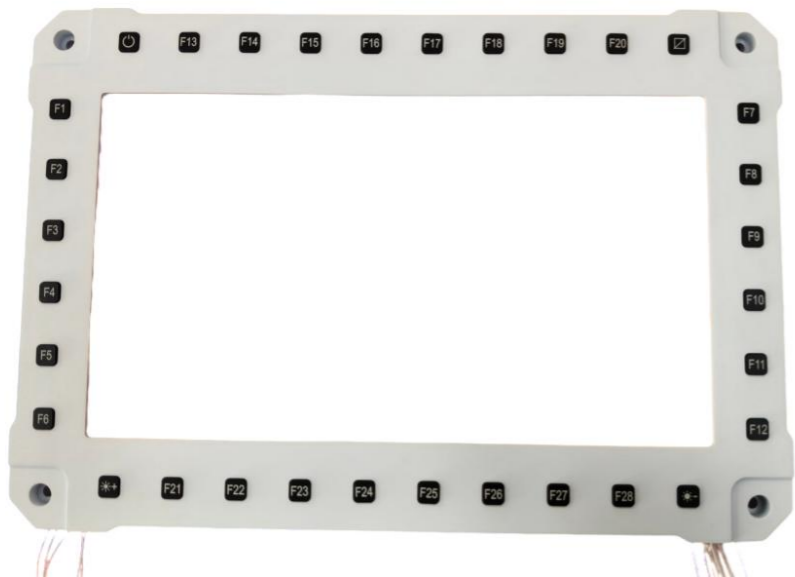



Shenzhen Davo Electronic Co., Ltd

Provide Top-Notch Industrial Keyboard, Touchpad & Trackball Items | Turn Your Idea into Products

Address:4th Floor, Building A, No. 1 Yujie Road, Qiaotou Community,, Fuhai Street, Bao'an District, Shenzhen, 518103 China

E-mail: kevin.deng@sz-davo.com



DAVO--- Kevin Deng

WhatsApp contact

website

